

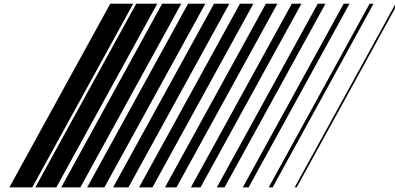

JVC



VIDEO CASSETTE RECORDER

HR-J231SA

CONTENTS

SAFETY FIRST	2
Safety Precautions	2
INSTALLING YOUR NEW RECORDER	3
Basic Connections	3
Tune The TV To Your Video Recorder	4
Select Television System	4
INITIAL SETTINGS	5
On-Screen Displays	5
Tuner Set	6
Clock Set	9
PLAYBACK	10
Basic Playback	10
Playback Features	11
RECORDING	14
Basic Recording	14
Recording Features	15
TIMER RECORDING	16
ShowView Setup	16
ShowView Timer Programming	18
Regular Timer Programming	20
Check And Cancel Programmes	21
Auto SP/LP Timer	21
EDITING	22
Edit To Or From Another Video Recorder	22
Edit From A Camcorder	23
TROUBLESHOOTING	24
QUESTIONS AND ANSWERS	26
SPECIFICATIONS	27
INDEX	28

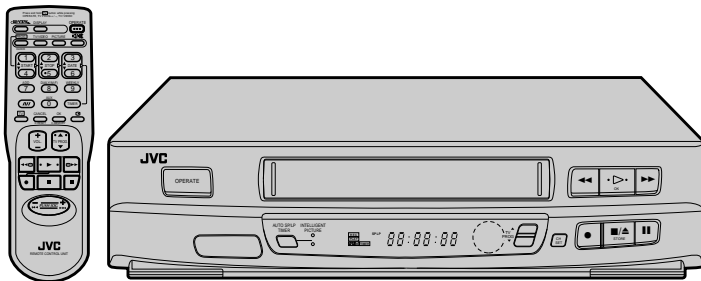

SHOWVIEW **VHS**
PAL

INSTRUCTIONS





Safety Precautions

The rating plate and the safety caution are on the rear of the unit.

WARNING: DANGEROUS VOLTAGE INSIDE

WARNING: TO PREVENT FIRE OR SHOCK HAZARD, DO NOT EXPOSE THIS UNIT TO RAIN OR MOISTURE.

CAUTION

- When you are not using the recorder for a long period of time, it is recommended that you disconnect the power cord from the mains outlet.
- Dangerous voltage inside. Refer internal servicing to qualified service personnel. To prevent electric shock or fire hazard, remove the power cord from the mains outlet prior to connecting or disconnecting any signal lead or aerial.

IMPORTANT

- Please read the various precautions on this page before installing or operating the recorder.
- It should be noted that it may be unlawful to re-record pre-recorded tapes, records, or discs without the consent of the owner of copyright in the sound or video recording, broadcast or cable programme and in any literary, dramatic, musical, or artistic work embodied therein.

The OPERATE button does not completely shut off mains power from the unit, but switches operating current on and off.

Failure to heed the following precautions may result in damage to the recorder, remote control or video cassette.

1. **DO NOT** place the recorder . . .
 - ... in an environment prone to extreme temperatures or humidity.
 - ... in direct sunlight.
 - ... in a dusty environment.
 - ... in an environment where strong magnetic fields are generated.
 - ... on a surface that is unstable or subject to vibration.
2. **DO NOT** block the recorder's ventilation openings.
3. **DO NOT** place heavy objects on the recorder or remote control.
4. **DO NOT** place anything which might spill on top of the recorder or remote control.
5. **AVOID** violent shocks to the recorder during transport.

MOISTURE CONDENSATION

Moisture in the air will condense on the recorder when you move it from a cold place to a warm place, or under extremely humid conditions—just as water droplets form in the surface of a glass filled with cold liquid. Moisture condensation on the head drum will cause damage to the tape. In conditions where condensation may occur, keep the recorder turned on for a few hours to let the moisture dry.

ABOUT HEAD CLEANING

Accumulation of dirt and other particles on the video heads may cause the playback picture to become blurred or interrupted. Be sure to contact your nearest JVC dealer if such troubles occur.

VHS
PAL

HQ

SHOWVIEW

- Only cassettes marked "VHS" can be used with this videorecorder.
- HQ VHS is compatible with existing VHS equipment.
- ShowView™ is a trademark of Gemstar Development Corporation. The ShowView system is manufactured under licence from Gemstar Development Corporation.

Basic Connections

It's essential that your video recorder be properly connected. Follow these steps carefully. THESE STEPS MUST BE COMPLETED BEFORE ANY VIDEO OPERATION CAN BE PERFORMED.

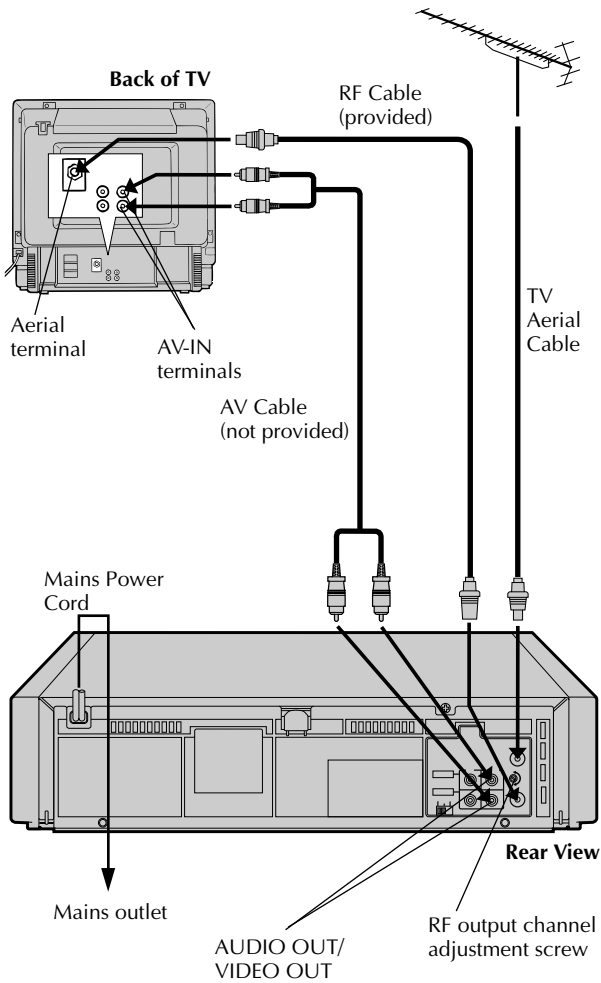

1 CHECK CONTENTS

Make sure the package contains all of the accessories listed in "Specifications" (pg. 27).

2 SITUATE RECORDER

Place the recorder on a stable, horizontal surface.

3 CONNECT RECORDER TO TV

The connection method you use depends on the type of TV you have.

RF CONNECTION

- To Connect To A TV With NO AV Input Terminals . . .
 - a- Disconnect the TV aerial cable from the TV.
 - b- Connect the TV aerial cable to the ANT. IN jack on the rear panel of the recorder.
 - c- Connect the provided RF cable between the RF OUT jack on the rear panel of the recorder and the TV's aerial terminal.

AV CONNECTION

- To Connect To A TV With AV Input Terminals . . .
 - a- Connect the aerial, recorder and TV as per "RF CONNECTION".
 - b- Connect an optional AV cable between the AUDIO OUT and VIDEO OUT connectors on the rear panel of the recorder and the TV's AV-IN terminals .

4 CONNECT RECORDER TO MAINS

Plug the end of the mains power cord into a mains outlet.



4

INSTALLING YOUR NEW RECORDER (cont.)

Tune The TV To Your Video Recorder

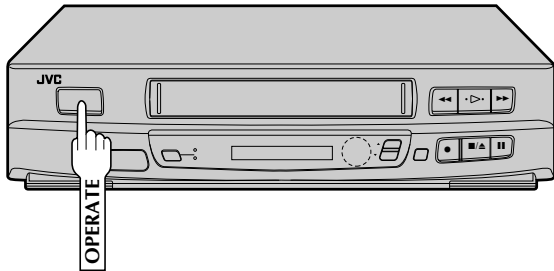

Back of VCR

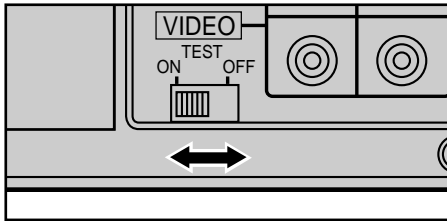

The video recorder sends picture and sound signals via the RF connecting cable to your TV on UHF channel 36.

1 TURN ON THE RECORDER

Press **OPERATE**.

2 SELECT OUTPUT MODE

Set the **TEST** switch on the back of the recorder to **ON**.

3 SET TV CHANNEL

Set your TV to the video channel (UHF channel 36). Two white bars appear on screen vertically.

- Tune the TV until the bars are as clear as they can be.
- Your TV should be set to the channel designated for use with a video recorder, or to a spare channel if there is not a specified video channel on your TV.

4 RESET OUTPUT MODE

Return the **TEST** switch to **OFF**.

NOTES:

- If CH36 is occupied by a local station, adjust the RF output channel adjustment screw to use another channel between CH32 and CH40 instead.
- If some interference noise is continually seen on the screen, consult your JVC dealer.



INITIAL SETTINGS

5

On-Screen Displays

Turn on the TV and select the VIDEO channel (or AV mode).

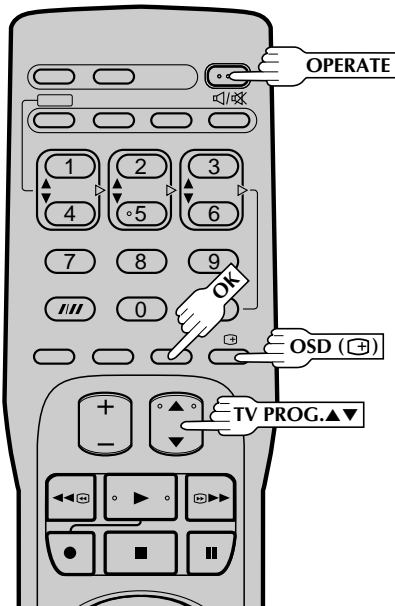
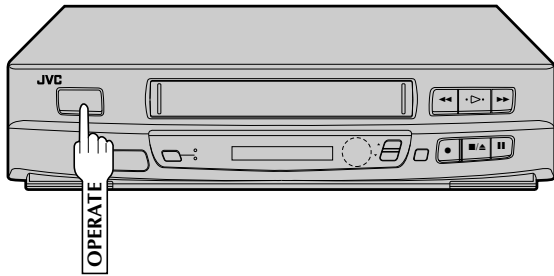

You can choose whether or not to have various operational indicators appear on screen, by setting this function ON or OFF. Use the buttons on the remote control for this procedure.

TURN ON THE RECORDER

1

Press **OPERATE**.

ACCESS O.S.D. SET SCREEN

2

Press **OSD (+)**. The O.S.D. (On-Screen Display) Set screen appears.

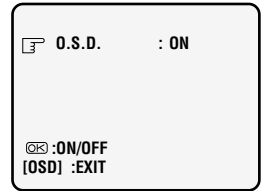

ENABLE/DISABLE ON-SCREEN DISPLAY

3

The default setting is "ON", so if you want on-screen displays, leave the setting as is and go to step 4. If you don't want the displays to appear, press **OK** to set "O.S.D." to "OFF".

CLOSE MODE SELECT SCREEN

4

Press **OSD (+)**.

The superimposed indication on the TV screen tells you what the recorder is doing.

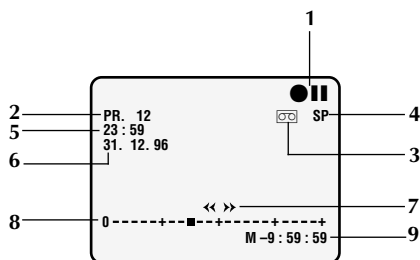

- 1- Operation mode indicators
- 2- Channel position number/Aux. indicator (AUX)
- 3- Cassette loaded mark
- 4- Tape speed SP/LP/EP (EP is for NTSC playback only)
- 5- Clock display
- 6- Current day/month/year
- 7- Tape direction
- 8- Tape position indicator (pg. 12)
- 9- Counter display (including Counter Memory indicator)



6

INITIAL SETTINGS (cont.)

Tuner Set

Turn on the TV and select the VIDEO channel (or AV mode).

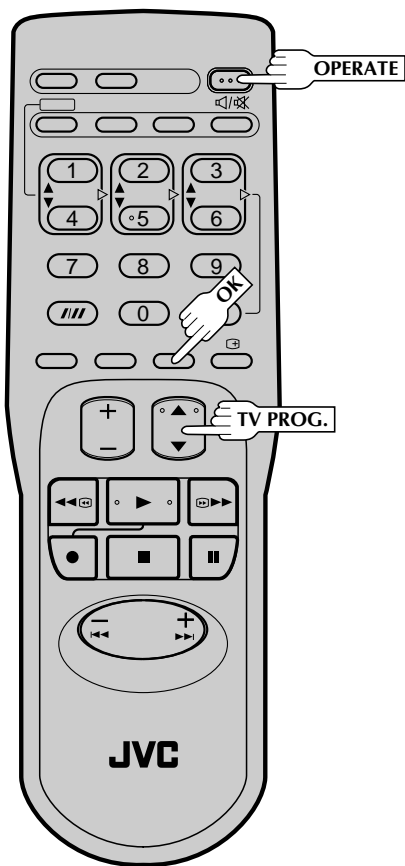
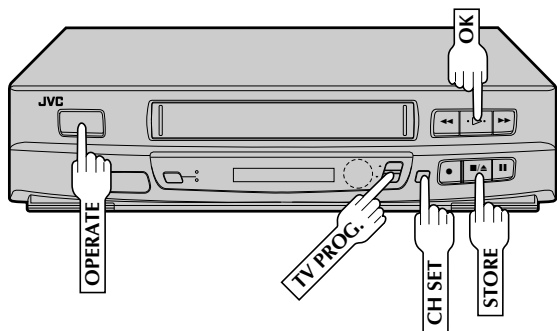

Your recorder needs to memorise all necessary stations in channel positions in order to record TV programmes. Once stored, you can call them up with the **TV PROG.** buttons without going through any vacant channels.

1 TURN ON THE RECORDER

Press **OPERATE**.

2 ACCESS CHANNEL SET MODE SELECT SCREEN

Press and hold **CH SET** for more than 2 seconds. The Channel Set Mode Select screen appears.

3 SELECT MODE

Press **TV PROG.▲/▼** to place the pointer next to "SEARCH/STORE", then press **OK**. The Band Select screen appears.



4 SELECT BAND

Press **TV PROG.▲/▼** to place the pointer next to the band of your choice, then press **OK** to initiate Auto Channel Search.

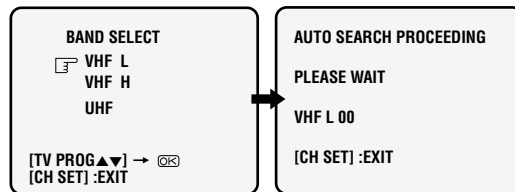

5 SET DESIRED CHANNEL

The following screen appears when a station is detected. To store the detected station, place the pointer next to "STORE" by pressing **TV PROG.▲/▼**, then press **OK**.

If you don't want to store the station, press **TV**

PROG.▲/▼ to place the pointer next to "CONTINUE", then press **OK**. Auto Channel Search will start resume.



- The blueback screen and the TV picture currently being broadcast appear alternately for 8 seconds each.

6 SELECT POSITION

6

Press **TV PROG.▲/▼** until an open position in which you want to store a channel appears, then press **OK**.



7 STORE CHANNEL

7

If fine tuning is not necessary, simply press **STORE**. For fine tuning adjustment, press **TV PROG.▲/▼** until the picture becomes clearer, then press **STORE**.



- To continue Auto Channel Search, press **TV PROG.▲/▼** to select "CONTINUE", then press **OK**. Repeat steps 5 – 7 as necessary.
- To set channels for other bands, press **TV PROG.▲/▼** to select "BAND SELECT", then press **OK** to go back to the Band Select screen. Repeat steps 4 – 7.

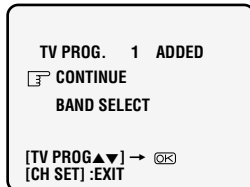

8 RETURN TO NORMAL SCREEN

8

Press **CH SET**.

Delete A Stored Channel

1

TURN ON THE RECORDER

Press **OPERATE**.

2

ACCESS CHANNEL SET MODE SELECT SCREEN

Press and hold **CH SET** for more than 2 seconds. The Channel Set Mode Select screen appears.

3

SELECT MODE

Press **TV PROG.▲/▼** to place the pointer next to "DELETE", then press **OK**.

4

SELECT CHANNEL

Press **TV PROG.▲/▼** until the position number of the channel you wish to delete appears.

- If the on-screen display is hard to read, refer to the recorder's display panel.



5

DELETE CHANNEL

Press **OK** twice. The screen shows the selected channel has been deleted.

- To delete another channel, press **OK** again, then repeat steps 4 – 5.



6

RETURN TO NORMAL SCREEN

Press **CH SET**.

NOTE:

If you skipped a channel by mistake, perform steps 1 – 8 on pages 6 and 7 to re-store it.

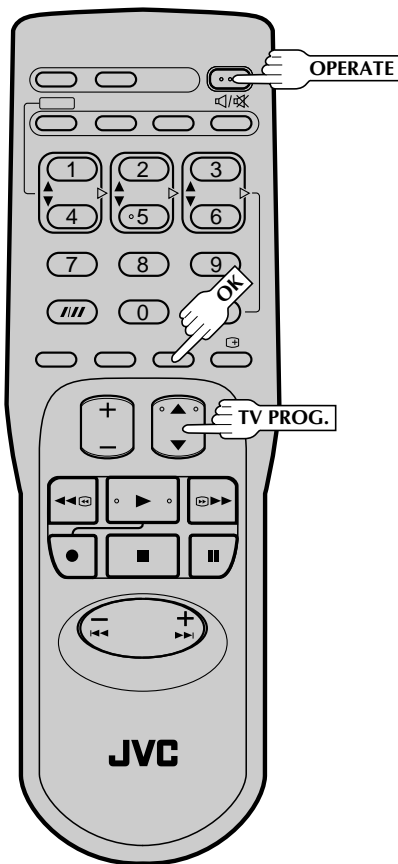
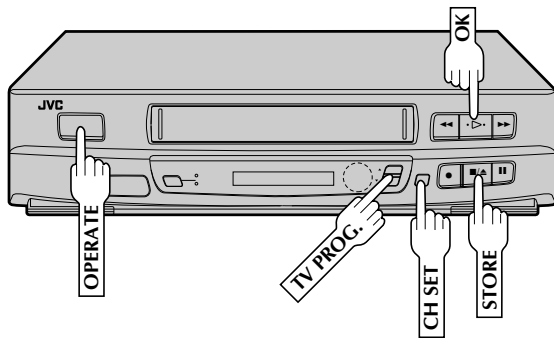

Fine-Tuning Channels Already Stored

1 TURN ON THE RECORDER

Press **OPERATE**.

2 ACCESS CHANNEL SET MODE SELECT SCREEN

Press and hold **CH SET** for more than 2 seconds. The Channel Set Mode Select screen appears.

3 SELECT MODE

Press **TV PROG.▲/▼** to place the pointer next to "FINE TUNING", then press **OK**.

4 SELECT CHANNEL

Press **TV PROG.▲/▼** so that the position number of the channel you want to fine-tune appears, then press **OK**.



5 PERFORM TUNING

Press **TV PROG.▲/▼** until the picture becomes clearer, then press **STORE**.

- To fine-tune another channel, press **OK** and repeat steps 4 – 5.



6 RETURN TO NORMAL SCREEN

Press **CH SET**.

Clock Set

Turn on the TV and select the VIDEO channel (or AV mode).

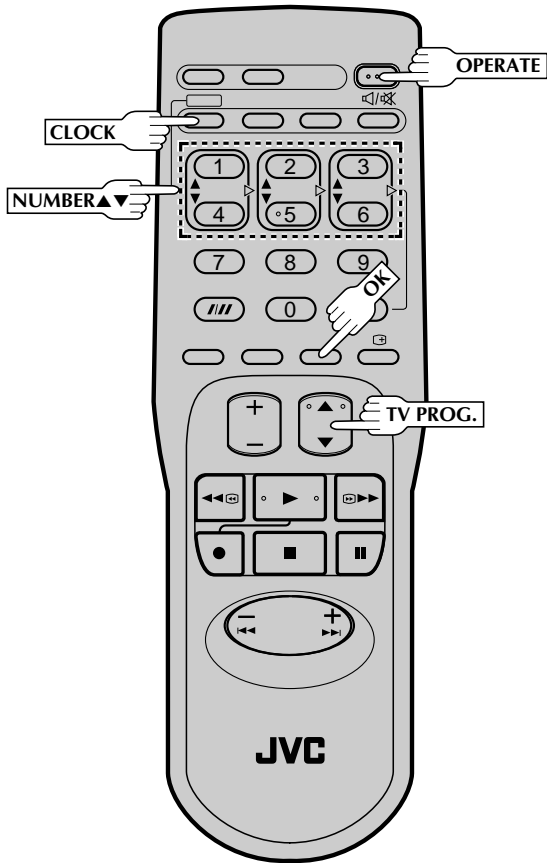
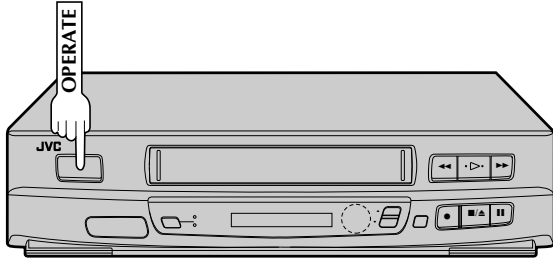

Use the buttons on the remote control for this procedure.

1

TURN ON THE RECORDER

Press **OPERATE**.

2

ACCESS MODE SELECT SCREEN

Press **CLOCK**.

- If the SHOWVIEW screen appears, press **CLOCK** again.

3

SELECT MODE

Press **TV PROG.▲/▼** to place the pointer next to "CLOCK SET", then press **OK** on the remote control. The Clock Set screen appears.

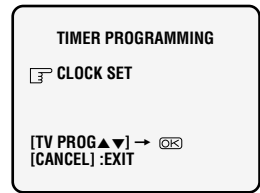

4

SET TIME

Use **NUMBER** key "1(▲)" or "4(▼)" to set the time.

- Press and hold either button to delay or advance the time by 30 minutes.



5

SET DATE

Use **NUMBER** key "2(▲)" or "5(▼)" to set the date.

- Press and hold either button to change the date by 15 days.

6

SET YEAR

Use **NUMBER** key "3(▲)" or "6(▼)" to set the year.

7

RETURN TO NORMAL SCREEN

Press **CLOCK**.

To Make Corrections

Perform steps 1 – 3 to call up the Clock Set screen, use **NUMBER** keys "1" – "6" to make the correction, then press **CLOCK**.

NOTE:

If, in step 7, the year digits are automatically cleared, it is possible that you have input 29th February for a non-leap year. Input the correct data.

Basic Playback

Turn on the TV and select the VIDEO channel (or AV mode).

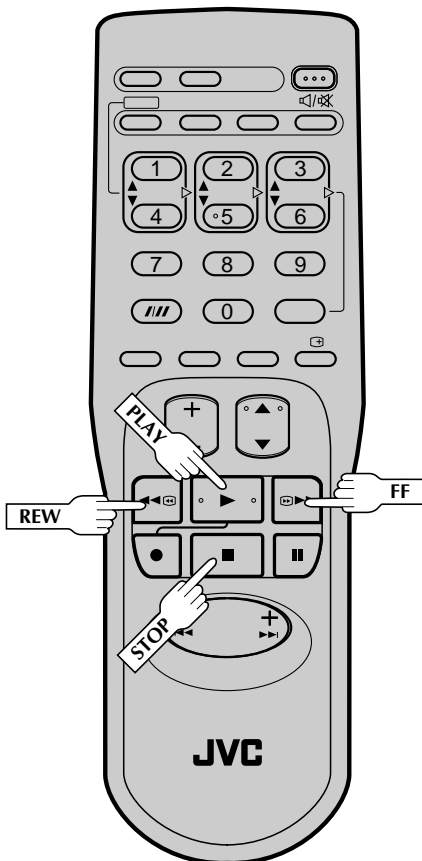
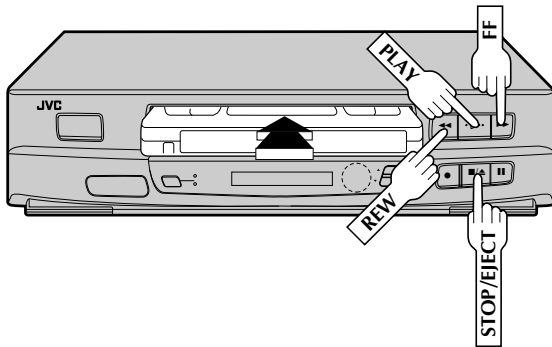

The easiest, most basic operation possible with your video recorder is tape playback. Already-recorded signals on a video tape are read by your video recorder and displayed on your TV just like a TV programme.

1 LOAD A CASSETTE

Make sure the window side is up, the rear label side is facing you and the arrow on the front of the cassette is point toward the recorder. Don't apply too much pressure when inserting.

- The recorder power comes on automatically and the counter is reset to 0:00:00.
- If the record safety tab has been removed, playback begins automatically.

2 FIND PROGRAMME START POINT

If the tape is advanced past the start point, press **REW**. To go forward, press **FF**.

3 START PLAYBACK

Press **PLAY**.

4 STOP PLAYBACK

Press **STOP** on the remote or **STOP/EJECT** on the recorder's front panel. Then press **STOP/EJECT** to remove the cassette.

Usable cassettes

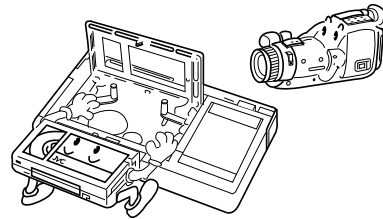

- Compact VHS camcorder recordings can be played on this video recorder. Simply place the recorded cassette into a VHS Cassette Adapter and it can be used just like any full-sized VHS cassette.
- This video recorder can record on regular VHS and Super VHS cassettes. However, it will record and play back regular VHS signals only. It is not possible to play back a recorded Super VHS tape.



Playback Features

Take advantage of special functions possible with the recorder's controls or the remote control.

Still Picture/Frame-By-Frame Playback

1

PAUSE DURING PLAYBACK

Press **PAUSE**. If there is vertical jitter, use the **TV PROG.** buttons to correct the picture.

2

ACTIVATE FRAME-BY-FRAME PLAYBACK

Press **PAUSE**.

OR

Press **PUSH JOG** ◀◀ or ▶▶.

To resume normal playback, press **PLAY**.

Slow Motion

1

ACTIVATE SLOW-MOTION PLAYBACK

During still picture, press and hold **PAUSE** for 2 seconds, then release. Press and release again to return to still picture.

OR

During still picture, press and hold **PUSH JOG** ◀◀ or ▶▶. Release to return to still picture.

To resume normal playback, press **PLAY**.

Variable-Speed Search

1

ACTIVATE VARIABLE-SPEED SEARCH

During playback, press **PUSH JOG** ◀◀ or ▶▶.

- The more times you press, the faster the playback picture moves.
- To decrease speed, press the button for the opposite direction.

To resume normal playback, press **PLAY**.

High-Speed Search

1

ACTIVATE HIGH-SPEED SEARCH

Press **FF** for forward high-speed search, or **REW** for reverse high-speed search.

- For short searches, press and hold **FF** or **REW** for over 2 seconds. When released, normal playback resumes.

To resume normal playback, press **PLAY**.

NOTE:

In the search, still or frame-by-frame playback mode, the picture will be distorted, and there may be a loss of colour.

Manual Tracking

Your video recorder is equipped with automatic tracking control. During playback, you can override this and adjust the tracking manually by pressing the **TV PROG.** buttons.

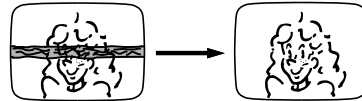

1

OVERRIDE AUTOMATIC TRACKING

Press **SP/LP** (//) on the remote to engage manual tracking.

2

ADJUST TRACKING MANUALLY

Press **TV PROG.** ▲/▼ to adjust tracking.

3

RETURN TO AUTOMATIC TRACKING

Press **SP/LP** (//) on the remote to re-engage automatic tracking.

NOTE:

When a new tape is inserted, the recorder enters the automatic tracking mode automatically.



Instant ReView

Simply by pressing a single button, the recorder power comes on, rewinds, and begins playback of the last timer-recorded programme. If you have several programmes recorded, you can easily access any of them.

NOTES:

- Before starting, make sure that the recorder is off and that the Timer mode is disengaged.
- Turn on the TV and select the VIDEO channel (or AV mode).

ACTIVATE INSTANT REVIEW

1 Press **REVIEW**. The recorder power comes on, then "I◀◀ 1" appears on screen and the recorder searches for the index code indicating the start of the last timer-recorded programme. Once it's found, playback begins automatically.

If you have, for example, 3 programmes and wish to watch the first of the 3 programmes, press **REVIEW** three times. The recorder searches and begins playback automatically. You can access a programme as far as 9 index codes away from the current tape position.

NOTE:

Instant ReView is not possible while the recorder is in the Timer mode.

Repeat Playback

Your video recorder can automatically play back the whole tape 20 times repeatedly.



START PLAYBACK

Press **PLAY**.

ACTIVATE REPEAT PLAYBACK

Press **PLAY** and hold for over 5 seconds, then release.

- "PLAY" on the display panel blinks slowly.
- The tape plays 20 times automatically, and then stops.

STOP PLAYBACK

Press **STOP** at any time to stop playback.

NOTE:

Pressing **PLAY**, **REW**, **FF** or **PAUSE** also stops Repeat Playback.

Intelligent Picture

To get a better picture when viewing tapes with noise such as rental tapes. Useful for normal playback of SP(or LP)-mode recorded tapes as well.

ACTIVATE INTELLIGENT PICTURE

1 During playback or stop, press **PICTURE**.

- The INTELLIGENT PICTURE indicator on the recorder lights.
- To turn it off, press **PICTURE** again.
- Intelligent Picture is not effective during search, slow, still, or frame-by-frame playback even though the INTELLIGENT PICTURE indicator on the recorder lights.

Tape Position Indicator

The tape position indicator appears on screen when, from the Stop mode, you press **FF**, **REW** or perform an Index Search. The position of "■" in relation to "0" (beginning) or "+" (end) shows you where you are on the tape.

"O.S.D." (pg. 5) must be set to "ON", or the indicator will not appear.

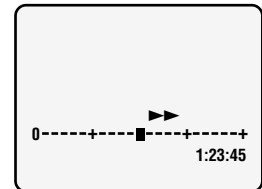

NOTE:

Depending on the type of tape used, there may be times when the indication is not correct.

Index Search

Your recorder automatically marks index codes at the beginning of each recording. This function gives you quick access to any one of 9 index codes in either direction.

NOTE:

Before starting, make sure the recorder is in the Stop mode.



1

ACTIVATE INDEX SEARCH

Press **PUSH JOG** ◀◀ or ▶▶. "◀◀ 1" or "▶▶ 1" is displayed on screen and search begins in the corresponding direction.

- To access index codes 2 through 9, press **PUSH JOG** ◀◀ or ▶▶ repeatedly until the correct index number is displayed.

Ex.: To locate the beginning of B from the current position, press **PUSH JOG** ◀◀ twice.

To locate the beginning of D from the current position, press **PUSH JOG** ▶▶ once.

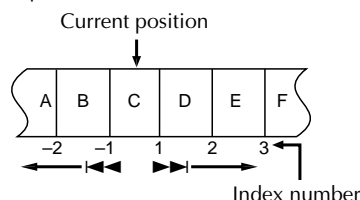

- When the specified index code is located, playback begins automatically.

NTSC Playback

Your video recorder is equipped with NTSC circuitry that can play back NTSC tapes.

1

LOAD A CASSETTE

Insert a cassette recorded in NTSC.

2

START PLAYBACK

Press **PLAY**.

- Some TVs shrink the picture vertically and place black bars at the top and bottom of the screen. This is not a malfunction on the part of either the video recorder or the TV.
- The picture may roll up and down. This can be corrected using the V-HOLD control found on some TVs. (This cannot be corrected if the TV does not have a V-HOLD control.)
- The counter and elapsed tape time readings will be incorrect.
- During search, still, or frame-by-frame playback, the picture will be distorted, and there may be a loss of colour.
- Depending on the type of TV, the top and bottom portions of superimposed displays may be cut off during NTSC playback.

Counter Memory

Returns to the counter reading of "0:00:00" to conveniently find a specific place on the tape automatically.

1

SET COUNTER MEMORY

Press **C. RESET** during playback at a point you wish to locate later. The counter reads "0:00:00". Then press **C. MEMORY**, and "M" appears on the front display panel.

2

ACTIVATE COUNTER MEMORY

When you wish to return to the designated point, press **STOP** and then **REW** or **FF**.

- The tape rewinds or fast-forwards and stops at about 0:00:00 automatically.
- To cancel Counter Memory, press **C.MEMORY** again.

Next Function Memory

You can set your recorder's power to go off automatically after the tape is fully rewound. Before starting, make sure the recorder is in the Stop mode.

For Automatic Power Off After Tape Rewind . . .

. . . press **REW**, then press **OPERATE** within 2 seconds.

NOTE:

If you want the power to be turned off automatically when the counter reads "0:00:00" (instead of at the beginning of the tape), press **C.MEMORY** so that the "M" mark appears before pressing **REW**.

Basic Recording

Turn on the TV and select the VIDEO channel (or AV mode).

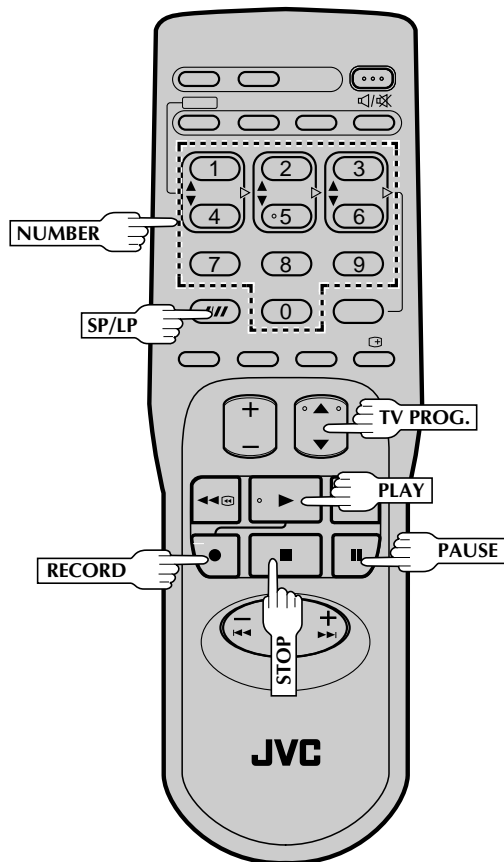
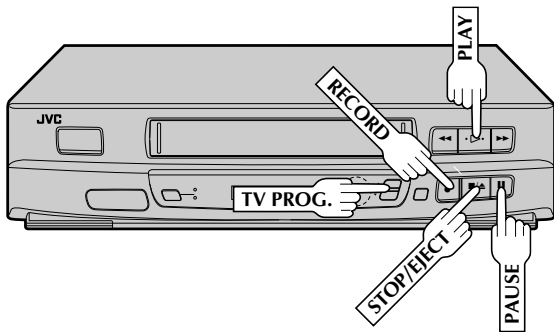

TV signals being received by the recorder's built-in tuner can be recorded onto a video tape. You can "capture" a TV programme using your video recorder.

LOAD A CASSETTE

Insert a cassette with the record safety tab intact.

- The counter is reset to 0:00:00 and the recorder power comes on automatically.

CHOOSE A PROGRAMME

Press **TV PROG.** ▲/▼ or the **NUMBER** keys to select the channel you wish to record.

SET TAPE SPEED

Press **SP/LP**. Check the SP/LP indicator on the recorder display panel to confirm the selected tape speed.

START RECORDING

Press and hold **RECORD** and **PLAY** on the remote control, or press **RECORD** on the recorder.

PAUSE/RESUME RECORDING

Press **PAUSE**. Press **PLAY** to resume recording.

STOP RECORDING

Press **STOP** on the remote control or **STOP/EJECT** on the recorder. Then press **STOP/EJECT** to remove the cassette.

Accidental erasure prevention

- To prevent accidental recording on a recorded cassette, remove its safety tab. To record on it later, cover the hole with adhesive tape.

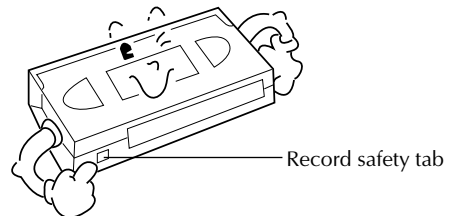

Recording Features

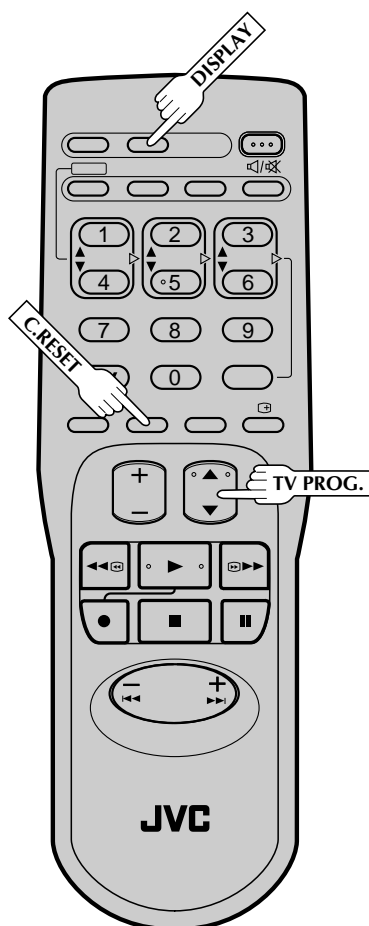
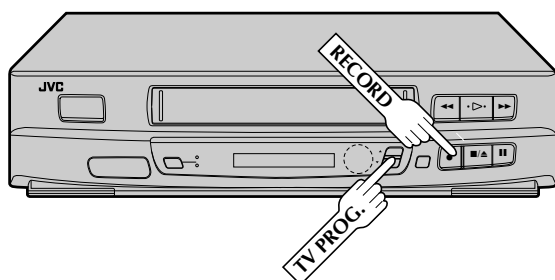

Record One Programme While Watching Another

1 SELECT CHANNEL TO WATCH

Once recording is in progress, all you need to do is to set the channel controls on the TV for the station you wish to view.

- The programme selected with the TV's channel controls appears on the TV screen while the one selected with the **TV PROG.** button(s) is recorded on the tape.

Elapsed Recording Time Indication

You can check the exact time of a recording.

1 SET COUNTER DISPLAY

Press **DISPLAY** until a counter reading appears on the display panel.

- Pressing the button changes the type of display: Channel, Clock or Counter.

2 RESET COUNTER

Press **C. RESET** before starting recording or playback.

- The counter is reset to "0:00:00" and shows the exact elapsed time as the tape runs.

Instant Timer Recording (ITR)

This easy method lets you record for from 30 minutes to 6 hours (selectable in 30-min. increments), and shuts the recorder off after recording is finished.

1 START RECORDING

Press **RECORD** on the recorder.

2 ENGAGE ITR MODE

Press **RECORD** again. "REC" blinks and 0:30 appears on the front display panel.

3 SET RECORDING DURATION

If you want to record for more than 30 minutes, press **RECORD** to extend the time. Each press extends recording time by 30 minutes.

NOTE:

You can only perform ITR using the **RECORD** button on the recorder's front panel.

ShowView Setup

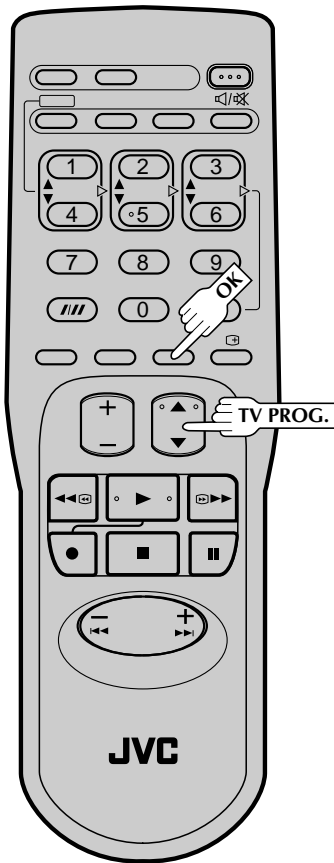
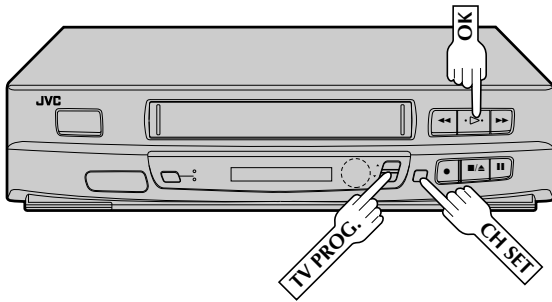

The ShowView timer programming system eliminates the need to input channel, date, start and stop time data when setting the timer record function. Simply key in the ShowView number for the TV program you wish to record (found in most TV listings) and the recorder's timer is automatically programmed.

Depending on the TV or cable stations that you receive and the channel numbers that they are received on in your area, you may have to make certain changes in your recorder's "Guide Prog. Set" menu to get proper results. Please read the following information carefully to find out which tasks you need to perform.

Before ShowView setup you must have performed the following procedures:

- Tuner setting (pg. 6)
- Clock setting (pg. 9)

Channel Number Matching

Most TV listings have a chart indicating the "Guide Prog." number assigned to each station for purposes of ShowView programming. Check the chart in your TV listings and see if the Guide Prog. numbers listed for the stations you receive are the same as the channel number on which each is received by your recorder .

If the numbers match, go directly to "ShowView Timer Programming" (pg. 18).

If the numbers are different, and you want to be able to timer record programs from those stations, you have to inform the recorder of the mismatch. Go to step 1. If you will not want to timer record from those stations, you can go directly to "ShowView Timer Programming" (pg. 18).

ACCESS CHANNEL SET MODE SELECT SCREEN

1 Press and hold **CH SET** for more than 2 seconds. The Channel Set Mode Select screen appears.



SELECT MODE

2 Press **TV PROG.▲▼** to place the cursor next to "GUIDE PROG. SET", then press **OK**. The Guide Prog. Set screen appears.

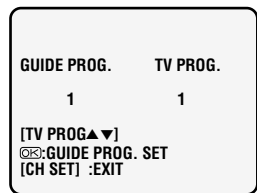

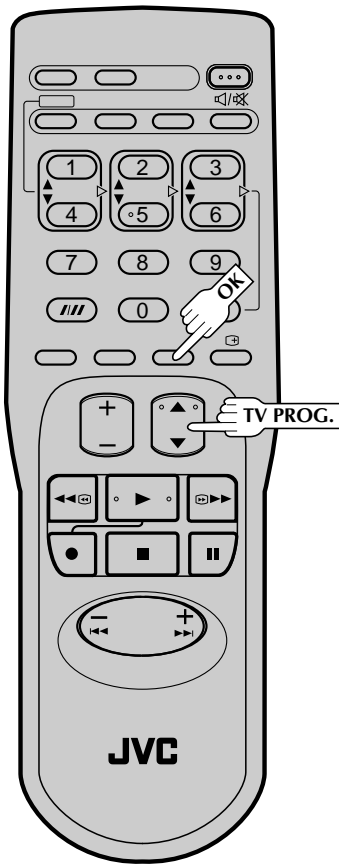
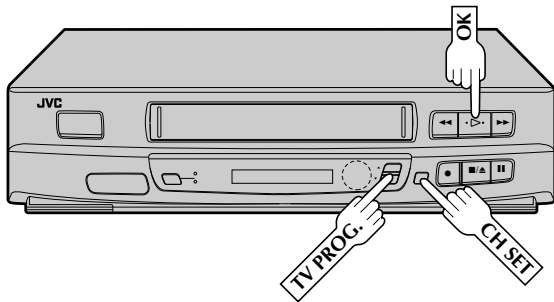

3

START SETTING

Press **OK**.

- The **GUIDE PROG.** number starts blinking.

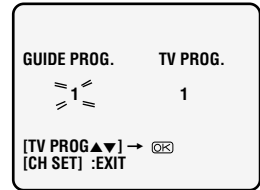

4

INPUT GUIDE PROG. NUMBER

Press **TV PROG.▲▼** to input the Guide Prog. number, then press **OK**.

- The **TV PROG.** number starts blinking.

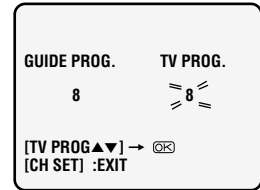

5

INPUT RECEIVING CHANNEL (TV PROG.) NUMBER

Press **TV PROG.▲▼** to input the TV Prog. number, then press **OK**.

- Repeat steps 3 – 5 as necessary.

6

RETURN TO NORMAL SCREEN

Press **CH SET**.

ShowView Timer Programming

Before performing ShowView timer recording, be sure to read "ShowView Setup" (pg. 16).

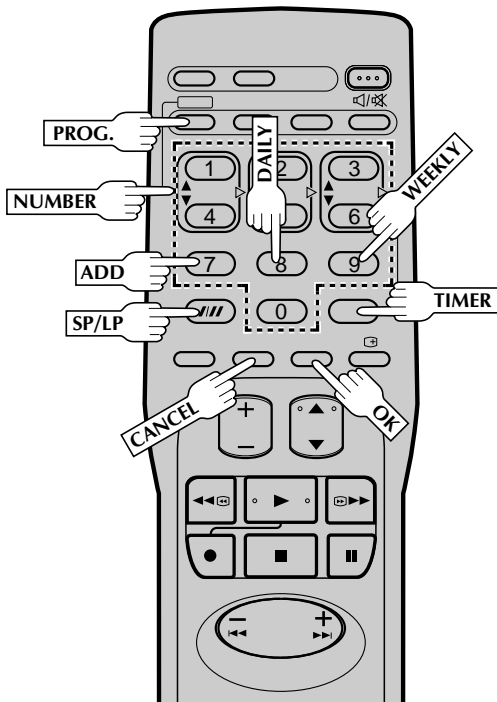
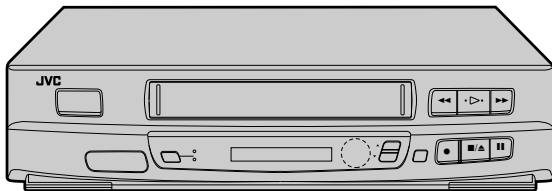

To Delay The Stop Time . . .

. . . press **ADD** after pressing **OK** in step 3. Each time you press, the Stop time is delayed by 5 minutes (meaning that 5 minutes of recording time is added). You can easily compensate for anticipated programme schedule delays this way.

To Timer-Record Weekly Or Daily Serials . . .

. . . after pressing **OK** in step 3, press **WEEKLY** (NUMBER key "9") for weekly serials or **DAILY** (NUMBER key "8") for daily serials (Monday-Friday).

Before performing the following steps:

- Insert a cassette with the safety tab in place. The recorder will come on automatically.
- Turn on the TV and select the VIDEO channel (or AV mode).

1 ACCESS SHOWVIEW SCREEN

Press **PROG.**

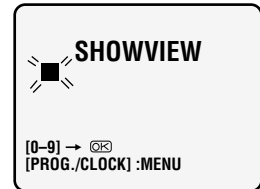

2 ENTER SHOWVIEW NUMBER

Press the appropriate **NUMBER** keys to enter the ShowView number.

- If you made a mistake, press **CANCEL** and enter the correct ShowView number.

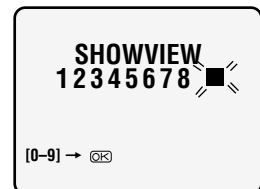

3 CHECK INPUT DATA

Press **OK**. The ShowView Programming screen appears.

- If the ShowView number you entered is incorrect, "ERROR" will be displayed on the screen. Press **CANCEL** and enter the correct ShowView number.

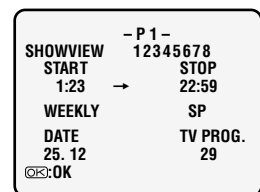

4 SET TAPE SPEED

Press **SP/LP**.

5 RETURN TO NORMAL SCREEN

Press **OK**.

- Repeat steps 1-5 for each additional programmes.

6 ENGAGE TIMER MODE

Press **TIMER**.

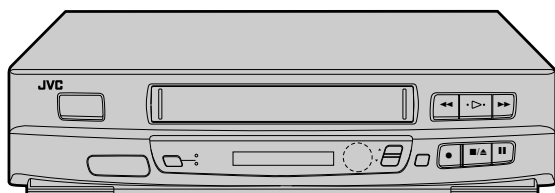
**NOTES:**

- You can programme this recorder to timer-record as many as 8 programmes. If you try to programme the recorder to record a ninth, "PROGRAM FULL" appears on screen. To record the extra programme, you must first cancel any unnecessary programmes (⏏ Check And Cancel Programmes).
- For safety, your recorder disables all other functions while in the Timer mode. If you want to use the recorder but its Timer mode is engaged, press **TIMER** and all other functions are operable. To re-engage the timer, press **TIMER**.
- In case of a power failure after programming, the recorder's memory backup keeps your selections for 18 hours.
- Backup time becomes shorter as the unit's internal parts become old. When this occurs, please consult your nearby JVC dealer.

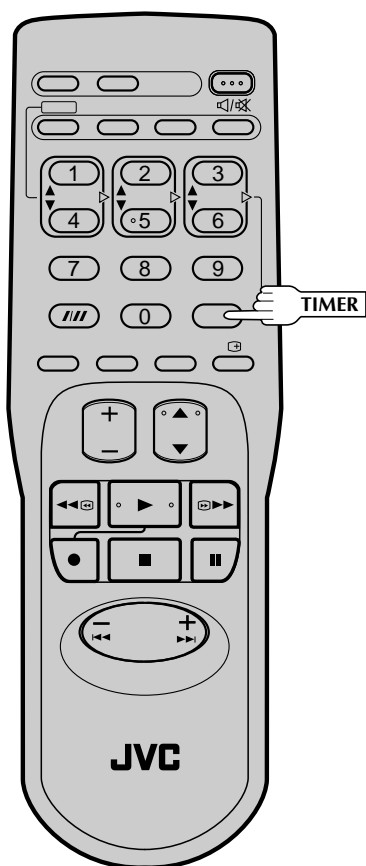

Regular Timer Programming

Remember, the clock must be set before you can programme the timer (pg. 9).

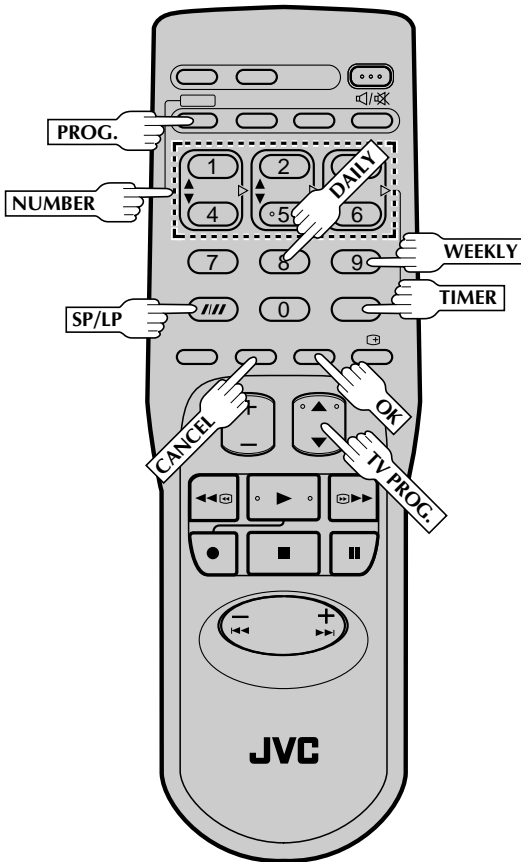
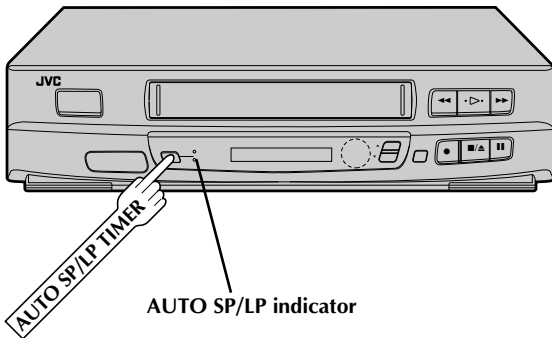

Before performing the following steps:

- Insert a cassette with the safety tab in place. The recorder will come on automatically.
- Turn on the TV and select the VIDEO channel (or AV mode).

ACCESS MODE SELECT SCREEN

1 Press **PROG.** twice.

ACCESS TIMER PROGRAMMING SCREEN

2 Press **TV PROG.▲/▼** to place the pointer next to "TIMER PROGRAMMING", then press **OK**.



ENTER PROGRAMME START TIME

3 Press **NUMBER** key "1(▲)" or "4(▼)" to enter the time you want recording to start.



- Press and hold either button to delay or advance the time by 30 minutes.
- If the Programme is already used, press **PROG.** until a vacant Programming screen appears.

ENTER PROGRAMME STOP TIME

4 Press **NUMBER** key "2(▲)" or "5(▼)" to enter the time you want recording to stop.



- Press and hold either button to delay or advance the time by 30 minutes.

ENTER PROGRAMME DATE

5 Press **NUMBER** key "3(▲)" or "6(▼)" to enter the date.

6 ENTER CHANNEL POSITION

Press **TV PROG.**▲/▼ to select the channel you wish to record.

START 21:00	- P1 - →	STOP 22:00
SP		
DATE 25.12	TV PROG. 1	
[1-6] [TV PROG▲▼] [PROG./CLOCK]:NEXT		

7 SET TAPE SPEED

Press **SP/LP** to set the tape speed.

- For each additional programme, press **PROG.** and repeat steps 3 – 7.

8 RETURN TO NORMAL SCREEN

Press **PROG.** as many times as necessary to return to normal screen.

9 ENGAGE RECORDER'S TIMER MODE

Press **TIMER**.

To Timer-Record Weekly Or Daily Serials . . .

. . . anytime during steps 3 through 7, press **WEEKLY** (NUMBER key "9") for weekly serials or **DAILY** (NUMBER key "8") for daily serials (Monday–Friday).

NOTES:

- You can programme this recorder to timer-record as many as 8 programmes. To record the extra programme, you must first cancel any unnecessary programmes (☞ Check And Cancel Programmes).
- For safety, your recorder disables all other functions while in the Timer mode. If you want to use the recorder but its Timer mode is engaged, press **TIMER** and all other functions are operable. To re-engage the timer, press **TIMER**.
- In case of a power failure after programming, the recorder's memory backup keeps your selections for 18 hours.
- Backup time becomes shorter as the unit's internal parts become old. When this occurs, please consult your nearby JVC dealer.

Check And Cancel Programmes

1 ACCESS TIMER PROGRAMMING SCREEN

Perform steps 1 and 2 of Regular Timer Programming to call up the Timer Programming screen.

- If the recorder is in the Timer mode, first press **TIMER** to exit the mode.

2 SELECT PROGRAMME

Press **PROG.** until the programme you wish to call up appears.

- Each time you press **PROG.** the next programme's information appears up to "P8" (Programme 8).
- If you want to make a correction, use **NUMBER** key "1" – "6" and **TV PROG.**▲/▼.
- If you want to cancel a programme, press **CANCEL**.

3 RETURN TO NORMAL SCREEN

Press **PROG.** as many times as necessary to return to normal screen.

- Press **TIMER** to engage the recorder's timer mode.

Auto SP/LP Timer

If, when recording in SP mode, there is not enough tape to record the entire programme, the recorder automatically switches to LP mode to allow complete recording.

1 ENGAGE AUTO SP/LP TIMER

Press **AUTO SP/LP TIMER** on the recorder front panel. The AUTO SP/LP TIMER indicator lights "orange".

For Example . . .

Recording a program of 210 minutes in length onto a 180-minute tape

Approximately 150 minutes Approximately 60 minutes

SP mode	LP mode
Total 210 minutes	

Make sure you press **AUTO SP/LP TIMER** before performing timer programming.

NOTES:

- The Auto SP/LP Timer feature is not available during ITR (Instant Timer Recording), and the feature will not work properly with any tapes longer than E-180 as well as some tapes of shorter lengths.
- Even if, in step 1, you press **AUTO SP/LP TIMER** and it lights "orange", that doesn't mean that the recorder will automatically change from SP to LP mode during the course of the recording. Watch the tape later to confirm.
- If you have programmed the recorder to timer-record 2 or more programs, the second programme and those thereafter may not fit on the tape if you engage the Auto SP/LP Timer mode. In this case, make sure the mode is not engaged, then set the tape speed manually during timer programming.
- There may be some noise at the point on the tape where the recorder switches from SP to LP mode.



Edit To Or From Another Video Recorder

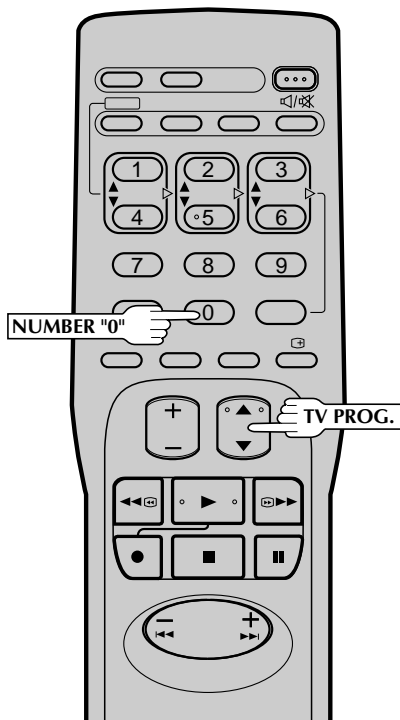

You can use your video recorder as the source player or the recording deck.

1 MAKE CONNECTIONS

Connect the player's AUDIO/VIDEO OUT connector to the recorder's AUDIO/VIDEO IN connector.

2 SET RECORDING DECK'S INPUT MODE

Set to AUX. With this video recorder, press **NUMBER** Key "0" or **TV PROG.**"AU" will appear instead of a channel number.

3 START SOURCE PLAYER

Engage its Play mode.

4 START RECORDING DECK

Engage its Record mode.

NOTE:

- All necessary cables can be obtained from your dealer.

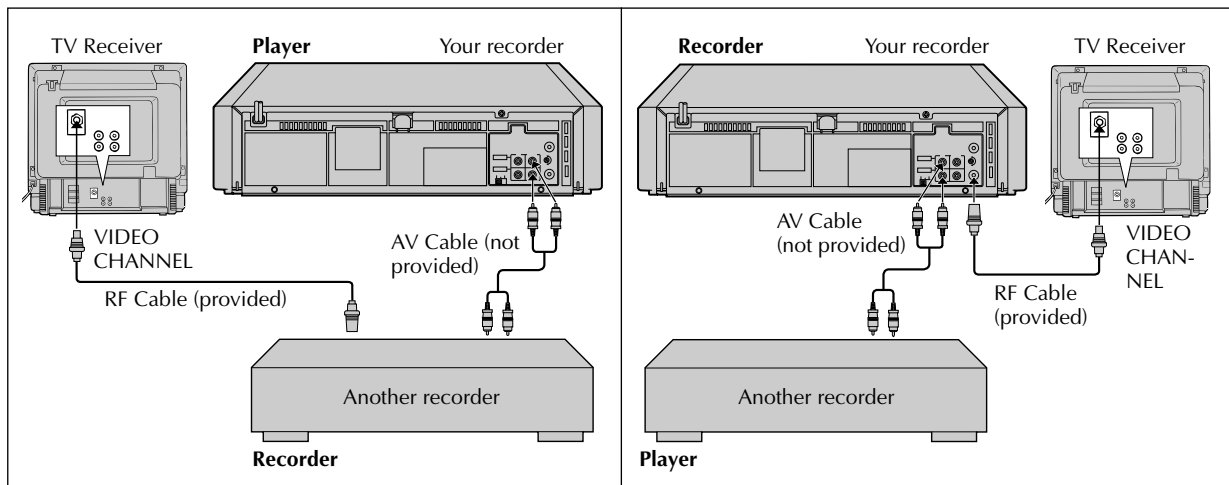

Edit From A Camcorder

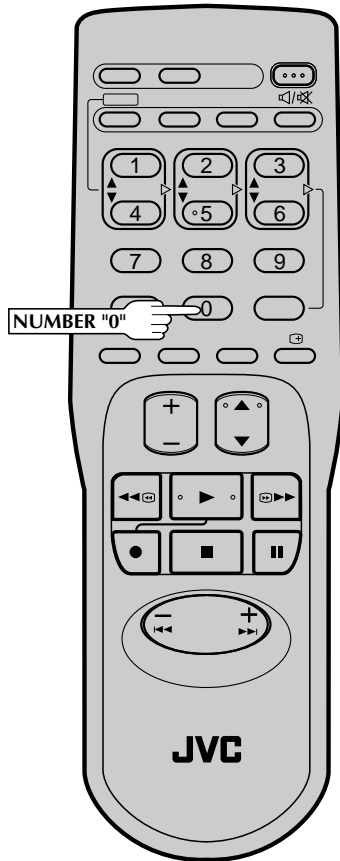

You can use a camcorder as the source player and your video recorder as the recorder.

1 MAKE CONNECTIONS

Connect the camcorder's AUDIO/VIDEO OUT connectors to the recorder's AUDIO IN and VIDEO IN connectors.

2 SET RECORDER'S INPUT MODE

Press **NUMBER** key "0". "AU" appears in place of a channel number.

3 START CAMCORDER

Engage its Play mode.

4 START RECORDER

Engage its Record mode.

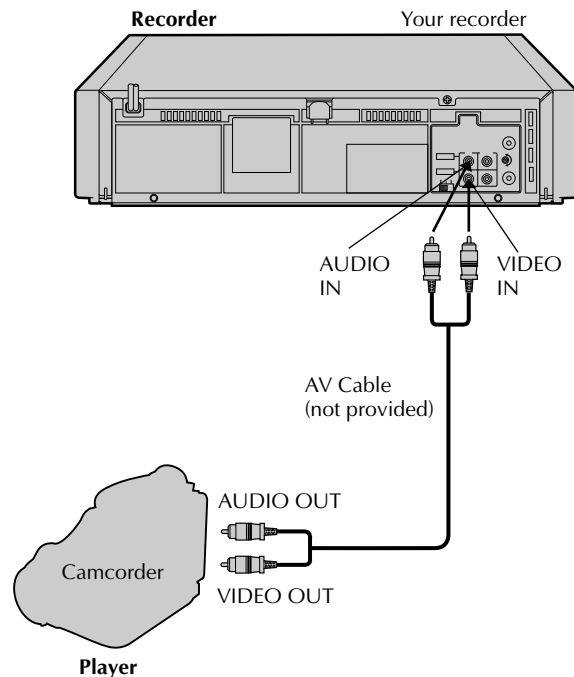

Before requesting service for a problem, use this chart and see if you can repair the trouble yourself. Small problems are often easily corrected, and this can save you the trouble of sending your video recorder off for repair.

POWER		
SYMPTOM	POSSIBLE CAUSE	CORRECTIVE ACTION
1. No power is applied to the recorder.	<ul style="list-style-type: none"> • The mains power cord is disconnected. 	Connect the mains power cord.
2. The clock is functioning properly, but the recorder cannot be powered.	<ul style="list-style-type: none"> • "TIMER" is displayed on the display panel. 	Press the TIMER button to turn the "TIMER" indicator off.
TAPE TRANSPORT		
SYMPTOM	POSSIBLE CAUSE	CORRECTIVE ACTION
1. The tape does not run during recording.	<ul style="list-style-type: none"> • The recorder is in the Pause mode. 	Press PLAY to disengage the Pause mode.
2. The tape stops during rewind or fast-forward.	<ul style="list-style-type: none"> • "M" is displayed on the display panel. 	Press C.MEMORY to deactivate the Counter Memory function and turn the "M" indicator off.
3. The tape will not rewind or fast-forward.	<ul style="list-style-type: none"> • The tape is already fully rewound or fast-forwarded. 	Check the cassette.
PLAYBACK		
SYMPTOM	POSSIBLE CAUSE	CORRECTIVE ACTION
1. The playback picture does not appear while the tape is running.	<ul style="list-style-type: none"> • If you're using the RF OUT connection, the TV receiver's channel selector is set to the wrong video channel. • If you're using the AV connection, the TV receiver is not set to the AV mode. 	<p>If you are using the RF OUT connection, set the TV receiver to the RF converter channel (UHF 36). (☞ pg. 4)</p> <p>If you are using the AV connection, set the TV to its AV mode.</p>
2. Noise appears during visual search.	<ul style="list-style-type: none"> • This is normal. 	
3. Noise appears during normal playback.	<ul style="list-style-type: none"> • The automatic tracking mode is engaged. 	Try manual tracking. (☞ pg. 11)
4. Noise appears during slow-motion playback.	<ul style="list-style-type: none"> • The automatic tracking mode is engaged. 	Try manual tracking. (☞ pg. 11)
5. Noise appears during still playback.		Press TV PROG. ▲ or ▼ a few times to remove the noise bars from the screen.
6. The playback picture is blurred or interrupted while TV broadcasts are clear.	<ul style="list-style-type: none"> • The video heads may be dirty. 	Consult your JVC dealer.
RECORDING		
SYMPTOM	POSSIBLE CAUSE	CORRECTIVE ACTION
1. Recording cannot be started.	<ul style="list-style-type: none"> • There is no cassette loaded, or the cassette loaded has had its Record Safety tab removed. 	Insert a cassette, or using adhesive tape, reseal the slot where the tab was removed.
2. TV broadcasts cannot be recorded.	<ul style="list-style-type: none"> • "AU" has been selected as the input mode. 	Set to the desired channel.

<p>3. Tape-to-tape editing is not possible.</p>	<ul style="list-style-type: none"> • The source (another video recorder, camcorder) has not been properly connected. • All necessary power switches have not been turned on. • The input mode is not correct. 	<p>Confirm that the source is properly connected.</p> <p>Confirm that all units' power switches are turned on.</p> <p>Set the input mode to "AU".</p>
<p>4. Camcorder recording is not possible.</p>	<ul style="list-style-type: none"> • The camcorder has not been properly connected. • The input mode is not correct. 	<p>Confirm that the camcorder is properly connected.</p> <p>Set the input mode to "AU".</p>

TIMER RECORDING

SYMPTOM	POSSIBLE CAUSE	CORRECTIVE ACTION
<p>1. Timer recording won't work.</p>	<ul style="list-style-type: none"> • The clock and/or the timer have been set incorrectly. • The timer is not engaged. 	<p>Re-perform the clock and/or timer settings.</p> <p>Press TIMER and confirm that "TIMER" is displayed on the display panel.</p>
<p>2. On-screen timer programming is not possible.</p>	<ul style="list-style-type: none"> • Timer recording is in progress. 	<p>Timer programming can't be performed while a timer recording is in progress. Wait until it finishes.</p>
<p>3. "TIMER" and "⏸" on the display panel won't stop blinking.</p>	<ul style="list-style-type: none"> • The timer is engaged but there's no cassette loaded. 	<p>Load a cassette with the Record Safety tab intact, or cover the hole using adhesive tape.</p>
<p>4. The cassette is automatically ejected, and "TIMER" and "⏸" on the display panel won't stop blinking.</p>	<ul style="list-style-type: none"> • The loaded cassette has had its Record Safety tab removed. 	<p>Remove the cassette and cover the hole with adhesive tape, or insert a cassette with the Record Safety tab intact.</p>
<p>5. "TIMER" blinks for 10 seconds and the Timer mode is disengaged.</p>	<ul style="list-style-type: none"> • TIMER has been pressed when there are no programs in memory, or the timer record information has been programmed incorrectly. 	<p>Check the programmed data and re-program as necessary, then press TIMER again.</p>
<p>6. The cassette is automatically ejected, the power shuts off and "TIMER" and "⏸" won't stop blinking.</p>	<ul style="list-style-type: none"> • The end of the tape was reached during timer recording. 	<p>The programme may not have been recorded in its entirety. Next time make sure you have enough time on the tape to record the entire programme.</p>
<p>7. ShowView does not timer-record properly.</p>	<ul style="list-style-type: none"> • The recorder's channel positions have been set incorrectly. 	<p>Refer to "ShowView Setup" and re-perform the procedure (pg. 16).</p>

OTHER PROBLEMS

SYMPTOM	POSSIBLE CAUSE	CORRECTIVE ACTION
<p>1. Whistling or howling is heard from the TV during camcorder recording.</p>	<ul style="list-style-type: none"> • The camcorder's microphone is too close to the TV. • The TV's volume is too high. 	<p>Position the camcorder so its microphone is away from the TV. Turn the TV's volume down.</p>
<p>2. The channel cannot be changed.</p>	<ul style="list-style-type: none"> • Recording is in progress. 	<p>Press PAUSE to pause the recording, change channels, then press PLAY to resume recording.</p>



PLAYBACK

- Q. What happens if the end of the tape is reached during playback or search?**
A. The tape is automatically rewound to the beginning.
.....
- Q. Can the video recorder indefinitely remain in the still mode?**
A. No. It stops automatically after 5 minutes to protect the heads.
.....
- Q. During search, slow, still and frame-by-frame playback, I can't hear any audio. What's the problem?**
A. This is normal.
.....
- Q. When returning from multi-speed search to normal playback, the picture is disturbed. Should I be concerned about this?**
A. No, it is normal.
.....
- Q. Noise bars appear during multi-speed search. What's the problem?**
A. This is normal.
.....
- Q. Other than preventing further recording, what effect does removing the Record Safety tab have?**
A. It disables marking of index codes.
.....
- Q. Sometimes, during Index Search, the video recorder can't find the programme I want to see. Why not?**
A. There may be index codes too close together.
.....

RECORDING

- Q. When I pause and then resume a recording, the end of the recording before the pause is overlapped by the beginning of the continuation of recording. Why does this happen?**
A. This is normal. It reduces distortion at the pause and resume points.
.....
- Q. Can the video recorder indefinitely remain in the Record-Pause mode?**
A. No. The video recorder goes to its Stop mode automatically after 5 minutes to protect the heads.
.....
- Q. What happens if the tape runs out during recording?**
A. The video recorder automatically rewinds it to the beginning.
.....

TIMER RECORDING

- Q. "REC" and "TIMER" remain lit on the display panel. Is there a problem?**
A. No. This is a normal condition for a timer recording in progress.
.....
- Q. Can I program the timer while I'm watching a tape or a TV broadcast?**
A. You won't see the picture as it is replaced by the on-screen menu, but the audio from the program or tape you're viewing can be heard.
.....

ATTENTION:

This recorder contains microcomputers. External electronic noise or interference could cause malfunctioning. In such cases, switch the recorder off and unplug the mains power cord. Then plug it in again and turn the recorder on. Take out the cassette. After checking the cassette, operate the unit as usual.



SPECIFICATIONS

27

GENERAL

Power requirement	: AC 220 – 240 V~, 50/60 Hz
Power consumption	: 17 W
Temperature	
Operating	: 5°C to 40°C
Storage	: -20°C to 60°C
Operating position	: Horizontal only
Dimensions (WxHxD)	: 400 x 94 x 276 mm
Weight	: 3.6 kg
Format	: VHS PAL standard
Maximum recording time	
(SP)	: 240 min. with E-240 video cassette
(LP)	: 480 min. with E-240 video cassette

VIDEO/AUDIO

Signal system	: PAL-type colour signal and CCIR monochrome signal, 625 lines 50 fields
Recording system	: Rotary two-head helical scan system
Signal-to-noise ratio	: 45 dB
Horizontal resolution	: 250 lines
Frequency range	: 70 Hz to 10,000 Hz
Input/Output	: RCA connectors (IN x 1, OUT x 1)

TUNER/TIMER

TV channel storage capacity	: 48 positions (+AUX position "AU")
Tuning system	: Voltage synthesized tuner
Channel coverage	: VHF (Low) 42 – 153MHz (High) 153 – 470MHz UHF 470 – 870MHz
Aerial output	: UHF channels 36 (Adjustable 32 – 40)
Memory backup time	: Approx. 18 hours.

ACCESSORIES

Provided accessories	: RF cable, Infrared remote control unit, "R03/UM-4" battery x 2
----------------------	------------------------------------------------------------------------

Specifications shown are for SP mode unless otherwise specified.

Design and specifications subject to change without notice.





FRONT VIEW

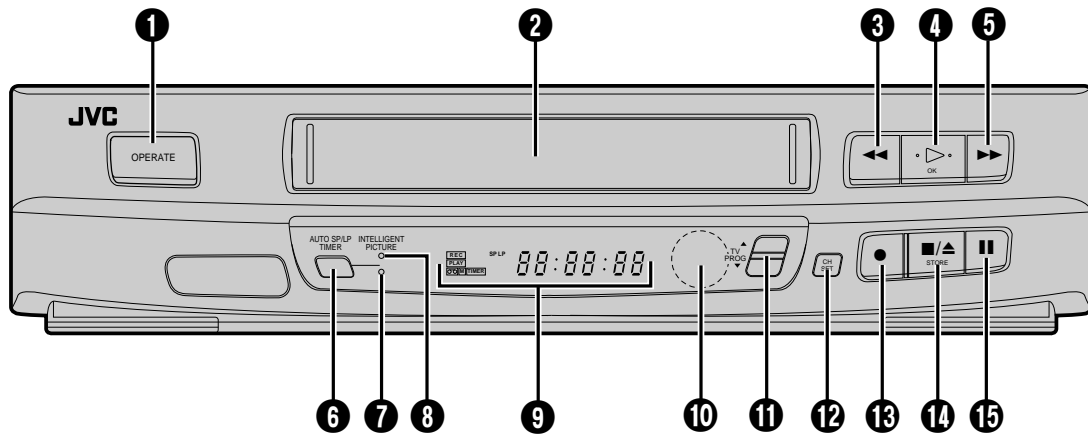

- 1 OPERATE Button (↗ pg. 4)
- 2 Cassette Loading Slot
- 3 Rewind [REW] Button (↗ pg. 10)
- 4 PLAY Button (↗ pg. 10)
OK Button (↗ pg. 6)
- 5 Fast Forward [FF] Button (↗ pg. 10)
- 6 AUTO SP/LP TIMER Button (↗ pg. 21)
- 7 AUTO SP/LP TIMER Indicator (↗ pg. 21)
- 8 INTELLIGENT PICTURE Indicator (↗ pg. 12)

- 9 Display Panel (↗ pg. 29)
- 10 Infrared Beam Receiving Window
- 11 TV PROG. ▲/▼ Buttons (↗ pg. 6)
- 12 CH SET Button (↗ pg. 6)
- 13 RECORD Button (↗ pg. 14)
- 14 STOP/EJECT Button (↗ pg. 10)
STORE Button (↗ pg. 7)
- 15 PAUSE Button (↗ pg. 11)

REAR VIEW

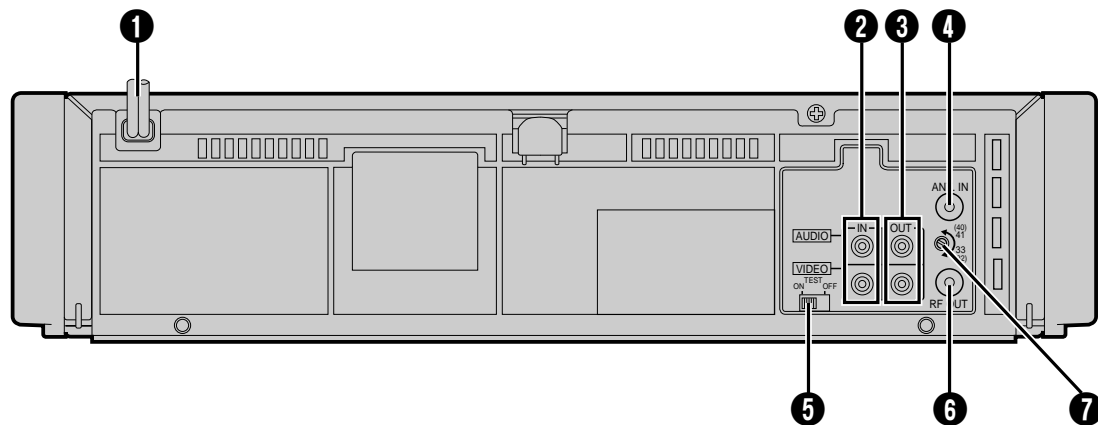

- 1 Mains Power Cord (↗ pg. 3)
- 2 AUDIO and VIDEO IN Connectors (↗ pg. 22)
- 3 AUDIO and VIDEO OUT Connectors (↗ pg. 3)
- 4 ANT. IN Connector (↗ pg. 3)

- 5 TEST Switch (↗ pg. 4)
- 6 RF OUT Connector (↗ pg. 3)
- 7 RF Output Channel Adjustment Screw (↗ pg. 4)



DISPLAY PANEL

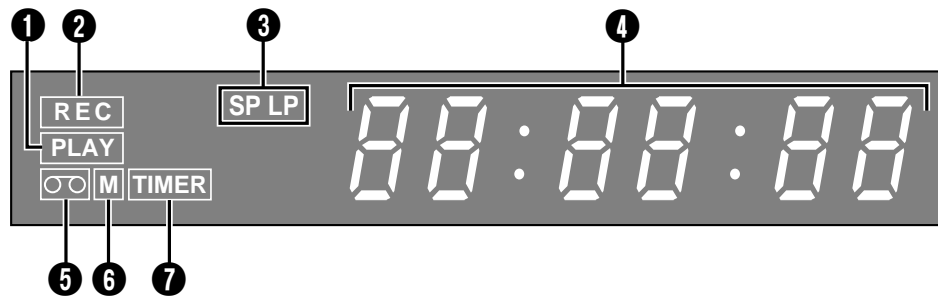

- ❶ PLAY Indicator (☞ pg. 10)
- ❷ REC Indicator (☞ pg. 14)
- ❸ Tape Speed Indicators (☞ pg. 14)
- ❹ Clock/Counter/Channel Display (☞ pg. 6)
- ❺ "Cassette Loaded" Mark
- ❻ Counter Memory Indicator (☞ pg. 13)
- ❼ "Timer" Indicator (☞ pg. 18)

REMOTE CONTROL

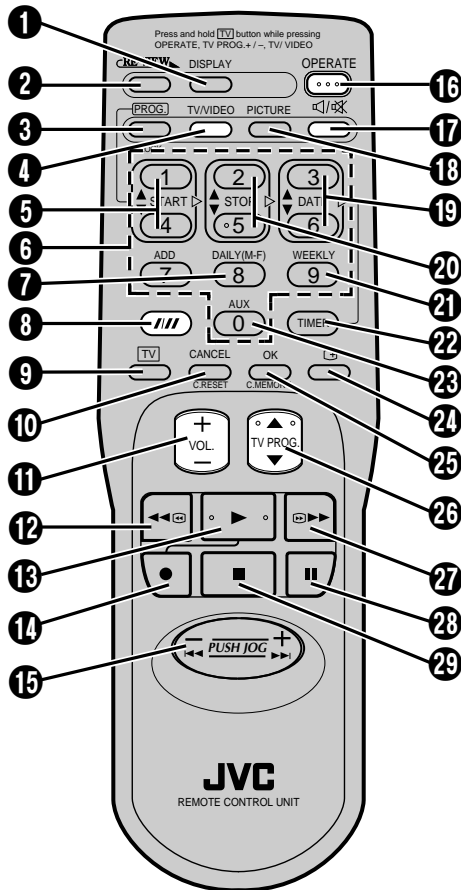

Buttons shown in white (□) can also be used to operate JVC TVs.

- ❶ DISPLAY Button (☞ pg. 15)
- ❷ REVIEW Button (☞ pg. 12)
- ❸ PROG Button (☞ pg. 18)
- ❹ TV/VIDEO Button (See below.)
- ❺ START ▲/▼ Buttons (☞ pg. 9)
- ❻ NUMBER Keys (☞ pg. 14)
- ❼ DAILY Button (☞ pg. 18)
- ❽ SP/LP Button (☞ pg. 11)
- ❾ TV Button (See below.)
- ❿ CANCEL Button (☞ pg. 18)
- ⓫ C.RESET Button (☞ pg. 13)
- ⓬ VOL. +/- Button (See below.)
- ⓭ Rewind [REW] Button (☞ pg. 10)
- ⓮ PLAY Button (☞ pg. 10)
- ⓯ RECORD Button (☞ pg. 14)
- ⓰ PUSH JOG Button (☞ pg. 11)
- ⓱ OPERATE Button (☞ pg. 4)
- ⓲ TV MUTE Button (See below.)
- ⓳ PICTURE Button (☞ pg. 12)
- ⓴ DATE ▲/▼ Buttons (☞ pg. 9)
- ⓵ STOP ▲/▼ Buttons (☞ pg. 9)
- ⓶ WEEKLY Button (☞ pg. 18)
- ⓷ TIMER Button (☞ pg. 18)
- ⓸ AUX Button (☞ pg. 22)
- ⓹ OSD (☞) Button (☞ pg. 5)
- ⓺ OK Button (☞ pg. 5)
- ⓻ C.MEMORY Button (☞ pg. 13)
- ⓼ TV PROG. ▲/▼ Buttons (☞ pg. 5)
- ⓽ Fast Forward [FF] Button (☞ pg. 10)
- ⓾ PAUSE Button (☞ pg. 11)
- ⓿ STOP Button (☞ pg. 10)

Installing Batteries

- ❶ Open the battery compartment cover.
- ❷ Insert 2 "R03/UM-4"-size batteries (provided) in the correct directions.
- ❸ Replace the cover.

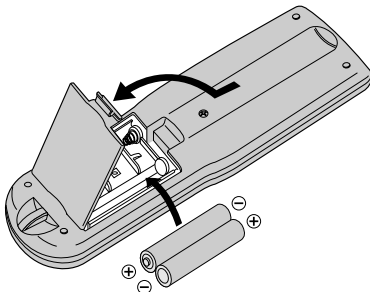

NOTE:

If for some reason the remote control doesn't work properly, remove its batteries, wait a short time and then try again.

How To Use

The remote control can operate most of your video recorder's functions, as well as basic functions of JVC TV sets.

- Point the remote control toward the sensor window.
- The maximum operating distance of the remote control is about 8 m.

Operating JVC TVs

You can also use the recorder's remote control to operate a JVC television.

To operate your TV, press and hold down the TV button while you press OPERATE, or TV PROG. ▲/▼, or TV/VIDEO, or VOL. +/-, or **///** (to select either Main or Sub programmes), or **☞/☞** (to mute the TV's sound).

NOTES:

- The way these buttons are used is determined by your TV. Use these buttons as instructed for your TV's remote control.
- TV channel cannot be changed using the numeric keys.



MEMO

Ruled lines for writing a memo.



HR-J231SA

JVC
VICTOR COMPANY OF JAPAN, LIMITED

COPYRIGHT © 1996 VICTOR COMPANY OF JAPAN, LTD.

SA  Printed in Japan
0796HOV*UN*VP